

## Grease separator EasyClean ground NS 2, Auto Mix, 1260-1700 mm, A/B

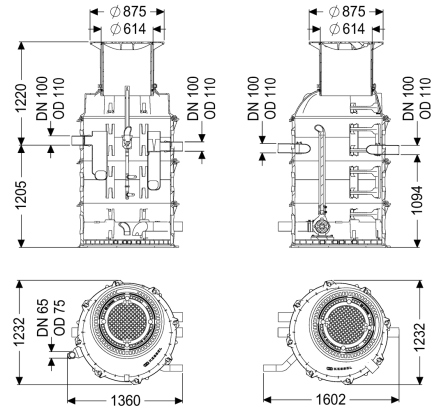

### Article information

Item no.: 93002/170B-DSP-TS

GTIN:

Price group: 60

### Advantages

- Program-controlled rinsing device
- Customisation possible through control unit
- Low-maintenance operation

### Description

The separator for greasy wastewater for underground installation consists of a grease separator and an engineering chamber. The two-piece system made of permanently resistant polymer (PE) is equipped with an integrated sludge trap and an integrated sampling device. Access for cleaning and maintenance work is provided by inspection openings, with polymer upper sections for continuously adjustable height and level compensation. The innovative Shredder-Mix-System with integrated macerating system is responsible for homogenising and circulating the tank contents. Cleaning takes place via an exterior submersible pump which is installed in a separate engineering chamber and can be disconnected from the tank by a shut-off valve. A direct disposal pipe socket is available for odour-neutral manual disposal. The fully automatic program run is controlled by a user-friendly control unit with multi-line display that can be integrated into the building management system through a potential-free contact. The control unit with 10 m long cable is installed in the engineering chamber in the factory. Cleaning and disposal can be started remotely using the remote control. Thanks to the customisable cleaning program with fast-selection function, cleaning can be adapted to the local circumstances as required. Observance of the Drinking Water Hygiene Directive can be guaranteed through the fully automatic rinsing of the drinking water pipes. The refill inlet and solenoid valves must be installed in a dry room on site. The connections between the grease separator and the engineering chamber as well as the reserve conduits and the connections must be made on site. (see connection set 917421). A load distribution slab must be installed on site for load class D. The reinforcement drawings are available from KESSEL. 20 year polyethylene warranty.

#### Variant

Note on installation depth:	Ground installation frost-free depth 1700 mm
Shut-off valve:	yes
Disposal variant:	Auto Mix
Shredder-Mix-System:	yes
Sludge bucket:	no
Nominal size (NS):	2
SonicControl:	no
Disposal system:	Disposal connection
Refill inlet in accordance with DIN 1988:	yes
Type of disposal:	automatic cleaning system
Water supply:	2 solenoid valves 1"
Sampling device:	Type NBG
Load-bearing capacity (DIN 19901):	E2

#### General characteristics

Material:	PE
Standard:	EN 1825
Installation situation:	underground installation
Delivery state:	Installation-ready (electrical components, connection parts must be connected on site)
Scope of delivery:	Storz-B coupling R 2 1/2" for disposal vehicle connection

#### Dimensions

Net weight:	490 kg
Gross weight:	510 kg
Groundwater resistant from lower edge of base section:	3000 mm
Diameter:	648 mm
Max. length:	2790 mm
Installation depth:	1260 - 1700 mm
Type of height adjustability:	vertically adjustable upper section, can be tilted by 5 degrees
Required access area, length:	1425 mm
Required access area, width:	1235 mm
<b>Tank/drain body</b>	
Distance pipe bottom outlet to tank bottom:	845 mm
Distance pipe bottom inlet to tank bottom:	955 mm
Outlet nominal size (OD):	110 mm
Outlet nominal size (DN):	100 mm
Inlet nominal size (OD):	110 mm
Inlet nominal size (DN):	100 mm
Connection inlet/outlet sockets:	PE-HD pipes in accordance with DIN 19537, PVC-KG pipes in accordance with DIN 19534, PP or AS
Clear width of tank (LW):	1000 mm
Clear width of entry (LW):	600 mm
<b>Coverage features</b>	
Type of cover:	Cover plate
Cover material:	Grey iron
Colour of cover:	black
Locking:	unlocked
Load class:	B 125 (EN 124)
Tightness:	odour-tight and surface water resistant
<b>Wastewater contents</b>	
Separator contents:	370 l
Total volume:	570 l
Contents of sludge trap:	200 l
Storage quantity of grease:	120 l
<b>Pumping device</b>	
Pump:	SPF 300 IP68
Number of pumps:	1
Weight, pump:	44 kg
Connection type:	Direct connection
Rated current:	6,2 A
Length of mains cable for pump:	5 m
Protection class:	I
Insulation class:	F
Protection class (pump):	IP 68
Temperature monitoring:	integrated

Max. temperature (permanent) of conveyed material:	40 °C
Max. pumping capacity:	60 m <sup>3</sup> /h
Max. pumping height:	17 m
Speed:	2850 U/min
Power P1:	3,6 kW
Power P2:	3 kW
Operating mode:	S2 - 30 min.
Type of fuse required (electrical protection):	Fuse protection through control unit 400 V
Type of pump connection cable:	H07RN-F 7G 1.5 mm <sup>2</sup>
Impeller type:	Radial impeller with macerating system
<b>Control</b>	
Control unit:	yes
Motor protection switch:	yes
Type of fuse required (RCD):	30 mA
Protection class control unit:	IP 54
Mains frequency:	50 Hz
Operating voltage:	400 V
Connection type:	Direct connection
Potential-free contact:	yes
GSM interface:	no
USB interface:	no
Log book function:	yes
Multi-line display:	yes
Battery buffering:	no
Self-diagnosis system (SDS):	yes
Rated current:	6,2 A