

## Controlfix backwater tech. mod. DN 125, two inlets in flow direction

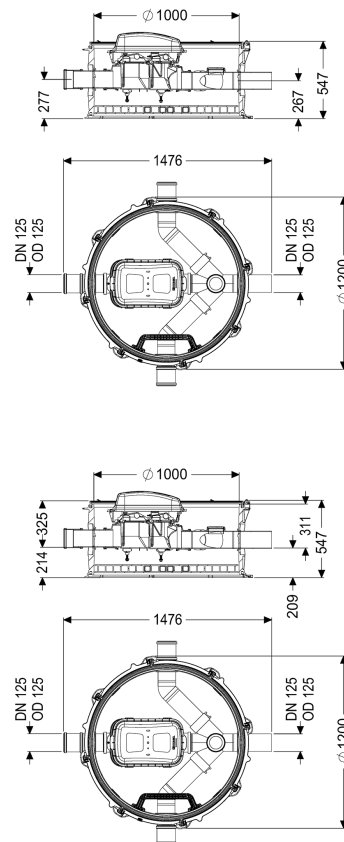

### Article information

Item no.: 851253  
 GTIN: 4026092079386  
 Price group: 60

### Advantages

- Komfort: expensive living or useful space is not lost
- No system noises or unpleasant odours and soiling in the building
- Straightforward installation thanks to low weight of the combined engineering chamber modules and variable upper sections for adaptation to the ground level

### Description

The backwater technical module is equipped with an integrated clean out Controlfix and access steps. Thanks to the modular KESSEL system, the clean out can easily be converted to a Staufix SWA Premium backwater valve, Staufix FKA or Pumpfix F backwater pumping station.

Variant

Chamber system:

modular chamber

**General characteristics**

Colour:	black
Material:	PE-HD
Type of wastewater:	with sewage
Installation situation:	underground installation
Delivery state:	Installation-ready (connection parts must be connected on site)
Approval:	Z-42.1-527

**Dimensions**

Net weight:	61 kg
Gross weight:	81 kg
Groundwater resistant from lower edge of base section:	3000 mm
Vertical drop between inlet and outlet:	9 mm
Width:	1200 mm
Height:	520 mm
Packaging dimension:	length
Packaging dimension:	width
Packaging dimension:	height

**Tank/drain body**

Channel:	continuous channel with inlets in the direction of flow right and left 90 degrees
Tank width max.:	1390 mm
Distance from centre of outlet pipe to tank bottom:	267 mm
Distance from centre of inlet pipe to tank bottom:	277 mm
Number of outlets:	1
Outlet nominal size (DN):	125 mm
Inlet nominal size (DN):	125 mm
Number of inlets:	3
Clear width of tank (LW):	1000 mm