

Controlfix backwater tech. mod. DN 125, closed channel passage

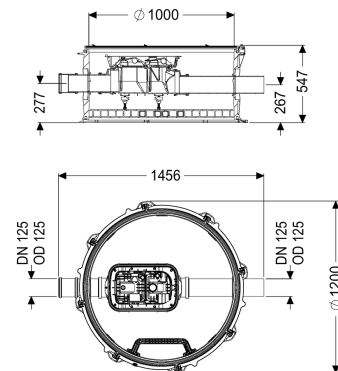

Article information

Item no.: 851251
 GTIN: 4026092079379
 Price group: 60

Advantages

- Komfort: expensive living or useful space is not lost
- No system noises or unpleasant odours and soiling in the building
- Straightforward installation thanks to low weight of the combined engineering chamber modules and variable upper sections for adaptation to the ground level

Description

The backwater technical module is equipped with an integrated clean out Controlfix and access steps. Thanks to the modular KESSEL system, the clean out can easily be converted to a Staufix SWA Premium backwater valve, Staufix FKA or Pumpfix F backwater pumping station.

Variant

Chamber system: modular chamber

General characteristics

Colour: black
 Material: PE-HD
 Type of wastewater: with sewage
 Installation situation: underground installation
 Delivery state: Installation-ready (connection parts must be connected on site)
 Approval: Z-42.1-527

Dimensions

Net weight: 64 kg
 Gross weight: 82 kg

Groundwater resistant from lower edge of base section:	3000 mm
Vertical drop between inlet and outlet:	9 mm
Width:	1200 mm
Height:	520 mm
Packaging dimension:	length
Packaging dimension:	width
Packaging dimension:	height
Tank/drain body	
Channel:	continuous channel
Tank width max.:	1390 mm
Distance from centre of outlet pipe to tank bottom:	267 mm
Distance from centre of inlet pipe to tank bottom:	277 mm
Number of outlets:	1
Outlet nominal size (DN):	125 mm
Inlet nominal size (DN):	125 mm
Number of inlets:	1
Clear width of tank (LW):	1000 mm