

Drain body Ferrofix, one-p, GF15 DN 100, vert., 300x300, grated cover L15

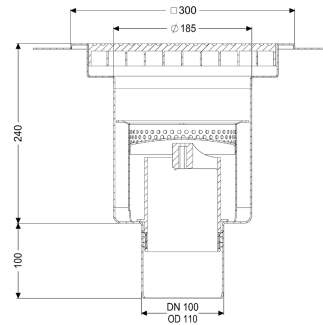

Article information

Item no.: 55148
 GTIN: 4026092107737
 Price group: 70

Advantages

- Made of particularly hygienic and mechanically highly resistant stainless steel

Description

The one-piece Ferrofix System 185 stainless steel floor drain is used for point drainage and is equipped with a removable odour trap, sludge bucket and grated cover. The floor drain is suitable for thin-layered floorings (e.g. epoxy resin) and has an all-round adhesive rim (15 mm deep and 50 mm folded outwards). The outlet socket is suitable for connection to SML cast iron pipes. With a drainage capacity III 2.4 l/s with 20 mm build-up.

Variant

System:	185
Contents of sludge trap:	yes
Waterproofing layer on the upper section:	Adhesive flange (suitable for moisture barriers)
Sealing water height:	50 mm
Discharge rate (l/s) with 20 mm threshold:	2,5
Outlet:	vertical

General characteristics

Material:	Stainless steel 14301
Outlet:	vertical
Glued flange height:	15 mm
Odour trap:	included

Dimensions

Length:	300 mm
Width:	300 mm

Height:	340 mm
Tank/drain body	
Number of outlets:	1
Outlet nominal size (DN):	100 mm
Socket version:	vertical
Coverage features	
Type of cover:	Slotted cover
Cover material:	Stainless steel 14301
Load class:	L 15 (EN 1253-1)
Grating material:	304 stainless steel
Shape of upper section:	square
Contents of sludge trap:	yes
Cover	
Grating material:	304 stainless steel