

Pumping station Aquapump XL Duo, STZ 1300-S1

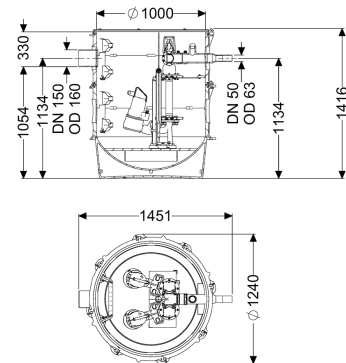

Article information

Item no.: 8743017
 GTIN: 4026092075715
 Price group: 60

Advantages

- Maximum safety
- Flexible installation
- Suitable for potentially explosive atmospheres

Description

The pumping station for wastewater with and without sewage is equipped with one or two submersible pumps, a backflow preventer and a shut-off valve for the pressure pipe. The collection tank made of permanently resistant polymer (PE) has an open pump tank (wet installation) with universal connection options. The station is controlled by a user-friendly control unit, which is optionally integrated in the building management system via a potential-free contact. Alternatively, alarm and collective fault messages can be output via a GSM interface. The KESSEL modular system provides different engineering chamber options as accessories for the further layout. Stainless steel pump removal chain available as accessory. Art. no. 680 528 = length 2 m 680 529 = length 3 m 680 530 = length 4 m 680 531 = length 5 m

Variant

Note on installation depth:	in combination with a chamber module
Type of system:	duo pump
Shut-off valve:	Shut-off valve made of polymer
Passage seal for conduit pipe (DN):	100
Access steps:	yes
Passage seal for ventilation pipe (DN):	100
Installation:	Wet installation
Pump control:	Control unit
Backflow preventer:	integrated
Pressure pipe connection:	horizontal

General characteristics

Colour:	black
Standard:	EN 12050-1
Type of wastewater:	with sewage
Installation situation:	underground installation
Delivery state:	Pre-mounted for final assembly on site (pumps and sensor system must be fitted on site and control unit must be connected)
System type:	Duo
Dimensions	
Net weight:	228 kg
Gross weight:	252 kg
Groundwater resistant from lower edge of base section:	3000 mm
Length:	1240 mm
Width:	1240 mm
Height:	1416 mm
Packaging dimension:	length
Packaging dimension:	width
Packaging dimension:	height
Tank/drain body	
Pressure pipe connection (DN):	50
Pressure pipe connection (OD):	63 mm
Distance from centre of outlet pipe to tank bottom:	1134 mm
Distance pipe bottom inlet to tank bottom:	1054 mm
Distance from centre of inlet pipe to tank bottom:	1134 mm
Distance from inlet pipe invert to top of tank:	330 mm
Inlet max. scoring (DN):	150 mm
Inlet nominal size (OD):	160 mm
Inlet nominal size (DN):	150 mm
Number of inlets:	1
Clear width of tank (LW):	1000 mm
Pumping volume:	300 l
Pumping device	
Pump:	STZ 1300
Number of pumps:	2
Weight, pump:	27 kg
Connection type:	Direct connection
Operating voltage:	400 V
Rated current:	2,5 A
Protection class:	I
Insulation class:	H
Cos phi - power factor:	0,8
Protection class (pump):	IP 68 (20m)
Temperature monitoring:	integrated

Max. temperature (permanent) of conveyed material:	40 °C
Max. pumping capacity:	20 m ³ /h
Max. pumping height:	21 m
Speed:	2900 U/min
Power P1:	1,3 kW
Power P2:	0,9 kW
Operating mode:	S1
Type of pump connection cable:	H07RN8-F 6G 1.5 mm ²
Impeller type:	Macerator
Length of mains cable for pump:	10 m
Control	
Control unit:	Comfort
Motor protection switch:	yes
Alarm sensor:	Level sensor
Level measurement instrument:	Level sensor
Type of level measurement:	hydrostatic
Protection class control unit:	IP 54
Mains frequency:	50 Hz
Operating voltage:	400 V
Connection type:	Direct connection
Potential-free contact:	yes
GSM interface:	yes
Log book function:	yes
Multi-line display:	yes
Battery buffering:	yes
Self-diagnosis system (SDS):	yes